

Contents

Basic Operations

General Guide

Watch Features

Using the Crown

Hands and the Day Indicator

Solar Charging

Using Mobile Link with a Mobile Phone

Getting Ready

- ① Installing required app on your phone
- ② Configuring Bluetooth settings
- ③ Pairing the watch with a phone

Auto Time Adjustment

Configuring World Time Settings

Correcting Hand Alignment

Phone Finder

Configuring Watch Settings

Changing the Home City Summer Time Setting

Checking the Watch Charge Level

Connection

- Connecting with a Phone
- Disconnecting from a Phone
- Using the Watch in a Medical Facility or Aircraft
- Unpairing
- If you purchase another phone
- Connecting a Different Watch to a Phone

Watch Settings

Selecting Your Home City's Time Zone

Setting the Time and Date

Configuring Dual Time Settings

Swapping the Home City Time and Dual Time

Hand Alignment Correction

To correct hand alignment

Moving To Another Time Zone

Other Information

Summer Time Switching

Supported Phone Models

Specifications

Mobile Link Precautions

Copyrights and Registered Copyrights

Troubleshooting

Basic Operations

This section provides an overview of the watch and its operations.

Note

- The illustrations included in this operation guide have been created to facilitate explanation. An illustration may differ somewhat from the item it represents.

General Guide

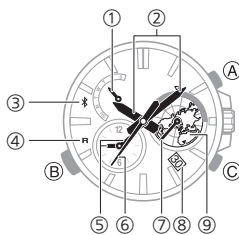

- Day of the week hand**
Indicates the day of the week in your Home City zone.
- Hour and minute hands**
Indicate the current time in your Home City zone.
- ✳ mark**
When the watch is connected with a phone, the second hand points to ✳.
- R mark**
When the watch is standing by for connection with a phone, the second hand points to "R".
- Small hour and minute hands**
Indicate the current time in your World Time (Dual Time) City.
- Second hand**
Indicates the current second in your Home City zone.
- Time zone hand**
Indicates your currently selected World Time (Dual Time) time zone.
- Day**
Indicates the day in your Home City zone.
- 3D Globe Dial**
Gives an idea of the approximate time at any location around the world. ▽ indicates midnight. The map's ▲ pointer indicates the Universal Time Coordinated zone (UTC±0).

Watch Features

● Home City time

The main time indicated by the watch is the current time in your Home City.

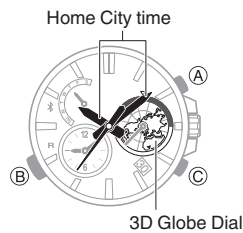

With the 3D Globe Dial, you can see if it is daytime or nighttime in your Home City. For example, if Tokyo is selected as the Home City and the 3D Globe Dial is positioned as shown in the figure below, Tokyo is on the nighttime side of the dial so the current time there 10:08 p.m.

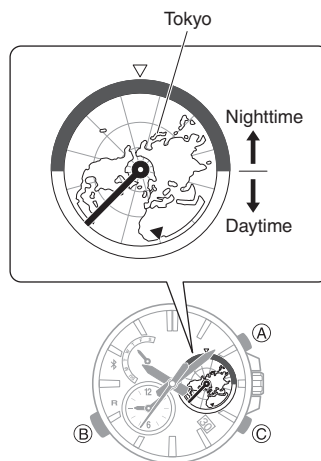

● Dual Time

This dial shows the current time in your Dual Time.

You can use the time zone hand to see if it is daytime or nighttime in your Dual Time. For example, when the time zone hand is as shown in the illustration below, the Dual Time is indicating 9:08 a.m.

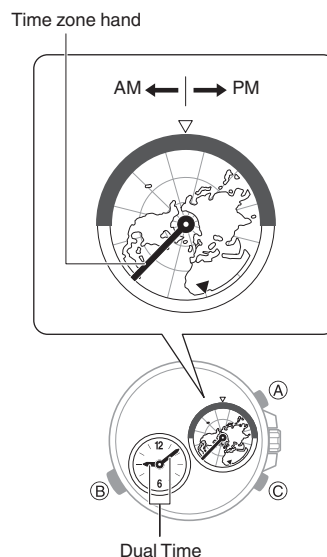

● Determining the Time in Another Time Zone

After you set your Home City zone (your current location), you can use the 3D Globe Dial to get an idea of times around the world. The figure below shows how to determine times with the 3D Globe Dial.

- The 3D Globe Dial ▽ pointer indicates midnight.

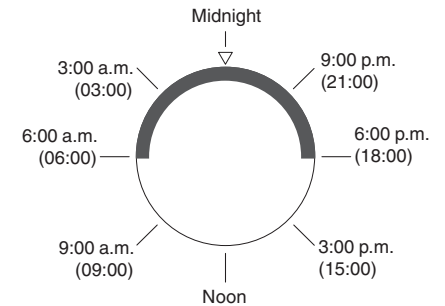

For example, when the 3D Globe Dial map is positioned as shown in the figure below, the approximate current times in other time zones are as indicated.

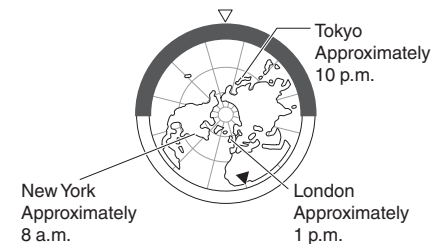

Note

- You can use the 3D Globe Dial to view standard times. You cannot use it to view summer times.

● 3D Globe Dial

The 3D Globe Dial shows a world map with the North Pole at the center. It rotates counterclockwise, once every 24 hours, just like the Earth does.

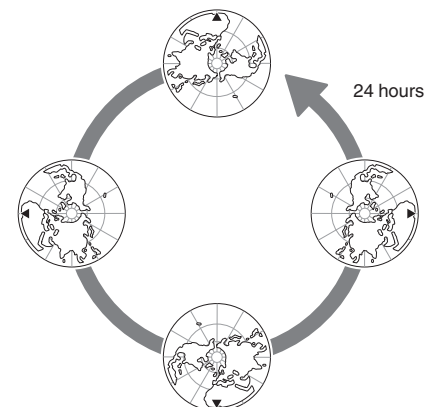

● Universal Time Coordinated and Other Time Zones

▲ on the 3D Globe Dial indicates the Universal Time Coordinated zone (UTC±0). Each time zone represents a time change of two hours, so you can view time zones around the world.

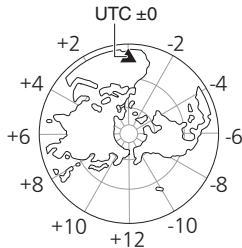

The coloring around the periphery of the 3D Globe Dial represents daytime and nighttime. The ▽ pointer at the top indicates midnight, so you can use this as a reference point to determine a.m. and p.m. times.

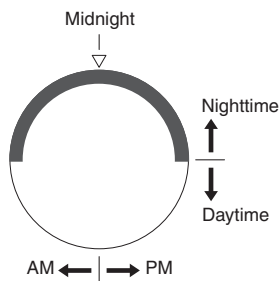

Note

- 3D Globe Dial time zones are different from the actual time zones used by countries and geographic areas.

Using the Crown

The watch's crown is a screw-in (screw lock) type. To use the crown, you first need to rotate it towards you (leftwards) to loosen it.

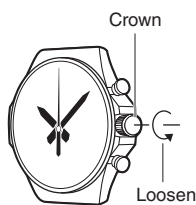

● Pulling Out and Pushing In the Crown

Before performing a crown operation, you need to pull it out to the first or second click as shown in the figure below. Do not pull the crown with too much force.

First click



Second click



Important!

- To prevent loss of water resistance and/or damage due to impact, be sure to screw the crown in by rotating it away from you as you push it in.

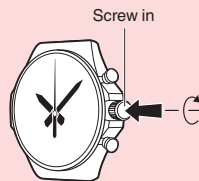

- When pushing the crown back in, take care not to apply too much force.

● Fast Forward/Fast Reverse

After pulling out the crown, rotating it quickly in succession in either direction will start a fast forward or fast reverse operation. While a fast forward or fast reverse hand operation is in progress, quickly rotating the crown in succession again will increase the speed even further.

● Stopping Fast Forward/Fast Reverse

Rotate the crown in the direction opposite that of the ongoing operation or press any button.

Note

- If you do not perform any operation for about nine minutes after pulling out the crown, crown operations will automatically become disabled. If that happens, push the crown back in and then pull it out again.

Hands and the Day Indicator

Day of the week hand

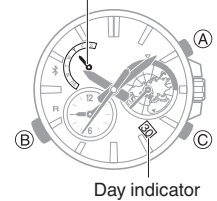

● Day of the Week and Day Indicator Operation

Changing the day setting of the watch will also cause the day of the week hand to move in conjunction with the day.

● Hour and Minute Hand Operation

The minute hand of this watch moves in conjunction with second hand movement.

● Day

- It can take anywhere from about 90 seconds to three minutes for the day indicator to change after timekeeping reaches midnight. The day of the week hand will move as the day indicator changes.
- The day may not be indicated correctly while the watch's crown is pulled out.

Solar Charging

This watch runs on power supplied from a rechargeable (secondary) battery that is charged by a solar panel. The solar panel is integrated into the face of the watch, and power is generated whenever the face is exposed to light.

● Charging the Watch

When you are not wearing the watch, put it in a location where it is exposed to bright light.

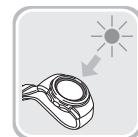

While you are wearing the watch, make sure that its face (solar panel) is not blocked from the light by the sleeve of your clothing. Power generation efficiency is reduced even when the face of the watch is blocked only partially.

YES



NO



Important!

- Depending on light intensity and local conditions, the watch may become hot to the touch when exposed to light for charging. Take care to avoid burn injury after charging. Also, avoid charging the watch under high-temperature conditions like the ones described below.
 - On the dashboard of a vehicle parked in the sun
 - Near an incandescent light bulb or other source of heat
 - Under direct sunlight or in other hot areas for long periods

Remaining Charge and Dead Battery

The charge level is indicated by watch hand movement. Functions become disabled as battery power goes low.

Important!

- Should battery go low or go dead, expose the face (solar panel) to light as soon as possible.

Note

- Exposing the watch face to light after the battery goes dead will cause the second hand to revolve counterclockwise until it stops at second 57. This indicates charging has started.

Low Battery Power

The second hand jumps at two-second intervals.



Second hand

Dead Battery

All hands and the day indicator are stopped.



Charging Time Guidelines

The table below shows guidelines for approximate charging times.

Required Charging Time for 1-day Use

Light Intensity		Approximate Charging Time
High	①	8 minutes
	②	30 minutes
Low	③	48 minutes
	④	8 hours

Time Required to Achieve Next Charge Level

Light Intensity		Charge Level 1	Charge Level 2
High	①	2 hours	21 hours
	②	5 hours	75 hours
Low	③	8 hours	121 hours
	④	82 hours	-

Light Intensity

- Sunny day, outdoors (50,000 lux)
- Sunny day, near a window (10,000 lux)
- Overcast day, near a window (5,000 lux)
- Indoor fluorescent lighting (500 lux)

Charge Level 1:

Time from dead battery until hand movement starts

Charge Level 2:

Time from hand movement starts until a full charge

Power Saving

Leaving the watch in a dark location for approximately one week will cause movement all of the watch's hands to stop in order to save power.

- Only the day indicator is operational.

Recovering from Power Saving Operation

Press any button or place the watch in a well-lit area to recover from power saving.

Using Mobile Link with a Mobile Phone

While there is a Bluetooth connection between the watch and phone, the watch time setting is adjusted automatically in accordance with the phone's time setting.

Note

- This function is available only while CASIO WATCH+ is running on the phone.
- This section describes watch and phone operations.
 - 🕒 : Watch operation
 - 📱 : Phone operation

Getting Ready

① Installing required app on your phone

To use the watch with a phone, first tap one of the links below and install the "CASIO WATCH+" app on the phone.

● iOS (iPhone) Users

<https://itunes.apple.com/us/app/id760165998?ls=1&mt=8>

● Android™ (GALAXY, etc.) Users

<https://play.google.com/store/apps/details?id=com.casio.watchplus>

② Configuring Bluetooth settings

Enable the phone's Bluetooth.

● iPhone Users

- 📱 On the Home Screen, tap "Settings" → "Bluetooth".
- 📱 Enable "Bluetooth".
- 📱 Tap "Settings" to return to the "Settings" screen.
- 📱 Tap in the following sequence: "Privacy" → "Bluetooth Sharing".
- 📱 Enable "CASIO WATCH+".

● Android Users

📱 Enable Bluetooth.





- If you are presented with a choice between "Bluetooth" and "Bluetooth Smart", select "Bluetooth Smart".

Note

- For details about setting procedures, see your phone documentation.

③ Pairing the watch with a phone

Before you can use the watch in combination with a phone, you first need to pair them. Once the watch is paired with a phone, you normally do not need to pair them again.

1. Move the phone you want to pair with close to (within one meter of) the watch.
2.  On the Home Screen, tap the "CASIO WATCH+" icon.
3.  Tap "EDIFICE".
4.  Tap "EQB-600".
5.  Perform operations as instructed by the app.
 - If a pairing prompt message appears, perform the operation shown on the phone screen.
 - When pairing starts, the second hand will move to 12 o'clock or to the "R" mark. When pairing is complete, the second hand will move to .

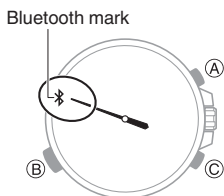

Auto Time Adjustment

The watch can be set to adjust its time setting automatically each day in accordance with the phone time.

● Using Auto Adjust

Your watch adjusts its time setting four times a day. It performs the adjustment operation automatically as you go about your daily life, without any operation required by you.



Important!

- The watch may not be able to perform auto time setting adjustment under the conditions described below.
 - While it is too far away from its paired phone
 - When communication is not possible due to radio interference, etc.
 - While the phone is updating its system

Note

- If there is a World Time City specified with CASIO WATCH+, its time will also be adjusted automatically.
- The watch will connect with the phone and perform auto time adjustment at around 5:00 a.m., 11:00 a.m., 5:00 p.m. and 11:00 p.m. The connection is automatically terminated after auto time adjustment is complete.

● Summer Time



Once the watch is connected with a phone and its time is adjusted with the phone time, its Home City time and World Time will automatically switch between standard time and summer time as required, even if the watch is no longer connected with the phone.

Summer Time Switching

- Changing the time setting manually with a watch operation will cancel auto standard time/summer time switching.
- A CASIO WATCH+ screen shows information about summer time periods.

● Triggering Immediate Time Adjustment

The watch will adjust its time setting to that of the phone immediately after they are connected with each other. Whenever you want to adjust the watch's time setting perform the procedure below to connect with a phone.

1.  On the Home Screen, tap the "CASIO WATCH+" icon.
2.  Press (B).

This causes the second hand to move to "R". The second hand will move to  when a connection is established between the watch and phone, and the time setting of the watch will adjust to the phone's time setting.

- The connection is terminated automatically after time adjustment is complete.



Configuring World Time Settings

Specifying a World Time City with CASIO WATCH+ causes the city's time to be indicated by the small hour and minute hands. Watch settings can be configured for auto summer time switching for the World Time City.

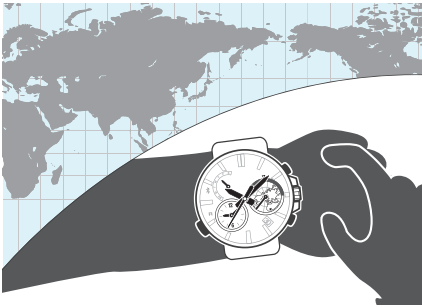

Note

- CASIO WATCH+ World Time lets you select from among approximately 300 cities as the World Time City.

● Selecting a World Time City

1. Tap the "CASIO WATCH+" icon.
2. Hold down the (B) button for about 1.5 seconds.
 - The second hand will move to "R". Keep (B) depressed until the second hand starts moving again and then stop at "R".
 - The second hand will move to $\frac{1}{2}$ when a connection is established between the watch and phone.

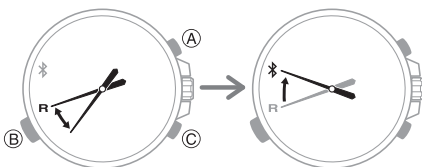

3. Tap "World Time".
4. Specify a World Time City by inputting a city name or by tapping its location on the on-screen map.

5. Perform the operation shown on the phone screen. The World Time setting will be reflected on the watch.

The time zone hand indicates the currently selected World Time zone, while the small hour and minute hands indicate the current time there.

- You can determine whether a World Time is a.m. or p.m. by checking the position of the time zone hand.

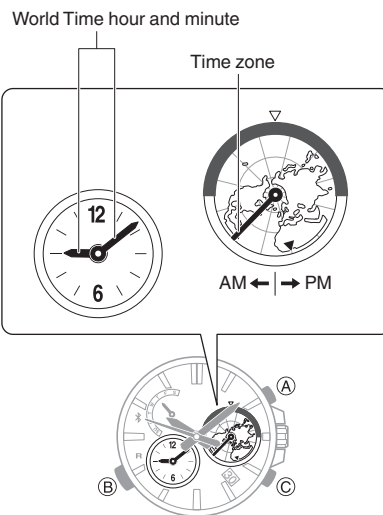

● Configuring the Summer Time Setting

1. Tap the "CASIO WATCH+" icon.
2. Hold down the (B) button for about 1.5 seconds.
 - The second hand will move to "R". Keep (B) depressed until the second hand starts moving again and then stop at "R".
 - The second hand will move to $\frac{1}{2}$ when a connection is established between the watch and phone.

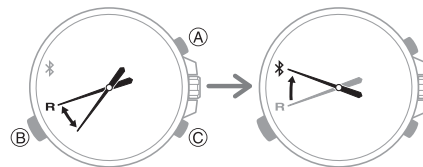

3. Tap "World Time".
4. Specify a World Time City by inputting a city name or by tapping its location on the on-screen map.

If your currently specified World Time City observes summer time, the summer time period will appear on the display.

5. Select the summer time switching method you want to use.
 - "Auto"
 - The watch switches between standard time and summer time automatically.
 - "OFF"
 - The watch always indicates standard time.
 - "ON"
 - The watch always indicates summer time.
6. Perform the operation shown on the phone screen.

Note

- When "Auto" is selected for standard/summer time switching, the watch will switch between standard time and summer time automatically. Do not need to change the time setting manually for changes between summer time and standard time. Even if you are in an area that does not observe summer time, you can leave the watch's summertime setting as "Auto".
- Changing the time setting manually with a watch operation will cancel auto standard time/summer time switching.
- A CASIO WATCH+ screen shows information about summer time periods.

● Swapping Your World Time and Home Time

- Tap the "CASIO WATCH+" icon.
- Hold down the (B) button for about 1.5 seconds.
 - The second hand will move to "R". Keep (B) depressed until the second hand starts moving again and then stop at "R".
 - The second hand will move to ⌘ when a connection is established between the watch and phone.

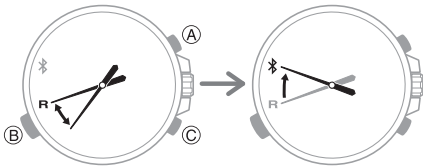

- Tap \oplus .
- Perform the operation shown on the phone screen to swap your Home Time with your World Time.
For example, if your Home City is Tokyo and the World Time City is New York, they will be swapped as shown below.

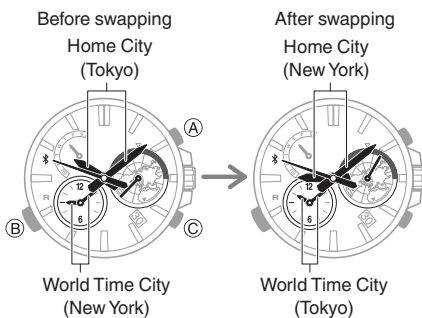

Note

- Auto time adjustment is not performed for 24 hours after swapping of the Home Time and World Time.

Correcting Hand Alignment

If the hands are out of alignment even though auto time adjustment is being performed, use CASIO WATCH+ to adjust them.

- Tap the "CASIO WATCH+" icon.
- Hold down the (B) button for about 1.5 seconds.
 - The second hand will move to "R". Keep (B) depressed until the second hand starts moving again and then stop at "R".
 - The second hand will move to ⌘ when a connection is established between the watch and phone.

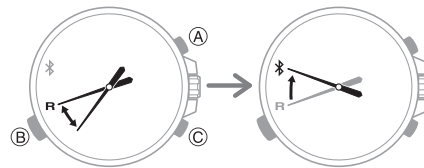

- Tap in the following sequence: $\equiv \rightarrow$ "Watch settings".
- Tap "Adjusting home positions".
- Perform the operation shown on the phone screen.

Phone Finder

You can use phone finder to trigger a tone on the phone to make it easy to find. The tone is forced to sound even if the phone is in the manner mode.

Important!

- Do not use this function in areas where phone call tones are restricted.
- The tone sounds at a high volume. Do not use this function when listening to phone output over earphones.

- If the watch is connected with a phone, press (B) to terminate the connection.

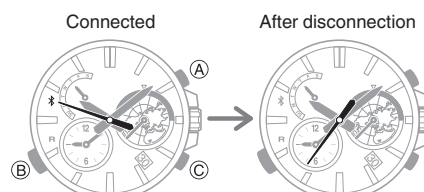

- Hold down (C) for about 0.5 seconds until the second hand points to "R".

The second hand will move to ⌘ when a connection is established between the watch and phone, and then the phone's ringtone will sound.

- It will take a few seconds before the phone tone sounds.

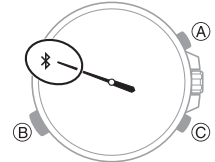

- Press any button to stop the tone.
 - You can press any watch button to stop the phone tone only during the first 30 seconds after it starts to sound.

Configuring Watch Settings

You can use CASIO WATCH+ to specify the amount of time until the Bluetooth connection is automatically terminated, and to configure other settings.

- Tap the "CASIO WATCH+" icon.
- Hold down the (B) button for about 1.5 seconds.
 - The second hand will move to "R". Keep (B) depressed until the second hand starts moving again and then stop at "R".
 - The second hand will move to ⌘ when a connection is established between the watch and phone.

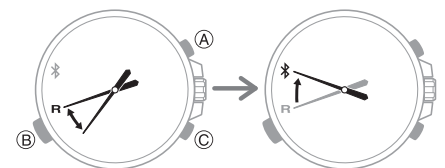

- Tap in the following sequence: $\equiv \rightarrow$ "Watch settings".
- Select the setting you want to change and then perform the operation shown on the phone screen.

Changing the Home City Summer Time Setting

1. On the Home Screen, tap the "CASIO WATCH+" icon.
2. Hold down the (B) button for about 1.5 seconds.
 - The second hand will move to "R". Keep (B) depressed until the second hand starts moving again and then stop at "R".
 - The second hand will move to when a connection is established between the watch and phone.

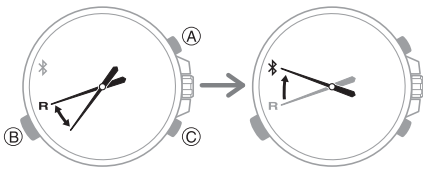

3. Tap in the following sequence: → "Watch settings".
4. Tap "Summer time setting".
5. Select the summer time switching method you want to use.
 - "Auto"
The watch switches between standard time and summer time automatically.
 - "OFF"
The watch always indicates standard time.
 - "ON"
The watch always indicates summer time.
6. Perform the operation shown on the phone screen.

Checking the Watch Charge Level

Use the procedure below to check the current charge level with CASIO WATCH+.

1. On the Home Screen, tap the "CASIO WATCH+" icon.
2. Hold down the (B) button for about 1.5 seconds.
 - The second hand will move to "R". Keep (B) depressed until the second hand starts moving again and then stop at "R".
 - The second hand will move to when a connection is established between the watch and phone.

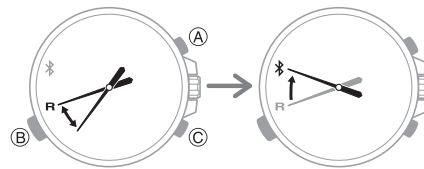

3. Use CASIO WATCH+ to check the charge level.

Connection

Connecting with a Phone

This section explains how to establish a Bluetooth connection between a phone that is paired with the watch.

- If the watch is not paired with the smartphone you want to connect with, perform the procedure under "[③ Pairing the watch with a phone](#)" to pair them.
1. Move the phone close to (within one meter of) the watch.
 2. While the second hand is not pointing to , hold down the (B) button for about 1.5 seconds.
 - The second hand will move to "R". Keep (B) depressed until the second hand starts moving again and then stop at "R".
 - The second hand will move to when a connection is established between the watch and phone.

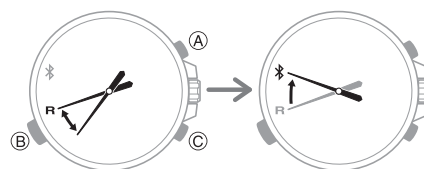

Important!

- If you have problems establishing a connection, it could mean that CASIO WATCH+ is not running on the phone. On the phone's home screen, tap the "CASIO WATCH+" icon. After the app starts up, hold down the watch's (B) button for about 1.5 seconds.

Note

- The connection will be terminated if you do not perform any operation on the watch or phone for a fixed amount of time. To specify the connection limit time, perform the following operation with: use CASIO WATCH+ to select "Watch settings" → "Connection time", and then specify a setting of 3 minutes, 5 minutes, or 10 minutes.
- While the watch is connected with the phone, the second hand makes one revolution with each passing minute.

Disconnecting from a Phone

Pressing (B) terminates the Bluetooth connection and returns the second hand to its normal operation.

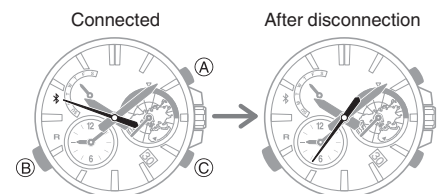

Using the Watch in a Medical Facility or Aircraft

Whenever you are in a hospital, on an aircraft, or in any other location where auto time adjustment may cause problems, disable it.

1. On the Home Screen, tap the "CASIO WATCH+" icon.
2. Hold down the (B) button for about 1.5 seconds.

The second hand will move to ✂ when a connection is established between the watch and phone.

- The second hand will move to "R". Keep (B) depressed until the second hand starts moving again and then stop at "R".

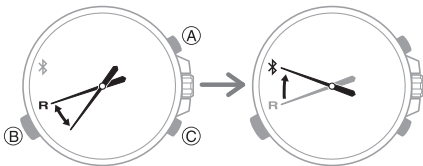

3. Tap in the following sequence: $\text{☰} \rightarrow$ "Watch settings".
4. Tap "Time adjustment".
5. Perform the operation shown on the phone screen.

Unpairing

1. If the watch is connected with a phone, press (B) to terminate the connection.

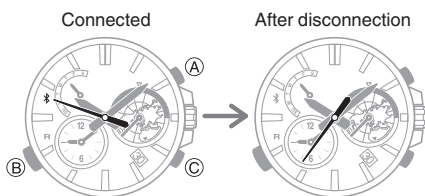

2. On the Home Screen, tap the "CASIO WATCH+" icon.
3. Tap the CASIO WATCH+ ⚙ icon.
4. In the "Previously registered watch" list, tap the watch you want to unpair.
5. Tap "Delete pairing registration".
6. Tap "Delete".

This unpairs the watch from the phone.

Note

- If you are unable to re-pair the watch with a phone after unpairing them, use the procedure below to delete pairing information from the watch and then perform the pairing operation again.

1. Pull out the crown to the second click.

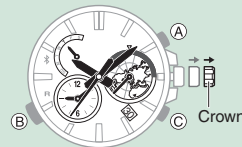

2. Hold down (C) for about five seconds.

This causes the 3D Globe Dial to perform one revolution and deletes the pairing information.

3. Push the crown back in.

If you purchase another phone

You need to perform the operation below whenever you want to establish a Bluetooth connection with a phone that is different from the one you are currently connected with.

1. Unpair the watch from your current (old) phone.
[Unpairing](#)
2. Pair the watch with your new phone.
[Pairing the Watch with a phone](#)

Connecting a Different Watch to a Phone

You should perform the steps below before pairing a different watch with the phone, such as after you buy a new watch.

● Pairing the Watch with a Phone

1. On the Home Screen, tap the "CASIO WATCH+" icon.
2. In the upper left corner of the screen, tap ☰ .
3. On the list that appears, tap the brand of the phone you want to connect with.
4. On the list that appears, tap the model name of the watch you want to connect with.
 - From this point, follow the instructions that appear on your phone's screen to complete the pairing operation.

● Connecting with a Watch that is Already Paired

1. On the Home Screen, tap the "CASIO WATCH+" icon.
2. Hold down the (B) button for about 1.5 seconds.
 - The second hand will move to "R". Keep (B) depressed until the second hand starts moving again and then stop at "R".
 - The second hand will move to ✂ when a connection is established between the watch and phone.

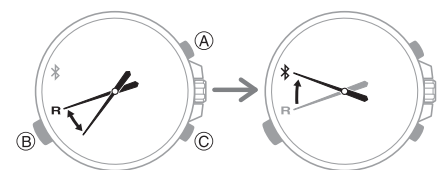

Important!

- A phone can be connected with only one watch at a time. To connect to another watch, you need to terminate the current connection.

Watch Settings

Use the procedure below to configure your Home City (current location) time and your Dual Time settings manually.

Selecting Your Home City's Time Zone

After you set your Home City zone (your current location), you can get an idea of times around the world on the 3D Globe Dial.

1. Pull out the crown to the second click.
This will cause the 3D Globe Dial to revolve so your currently set Home City time zone becomes positioned at ▽.
2. Adjust the hour and minute hand positions so they are set approximately to the current time in your current location (Home City).

(A) button: Hold down for about one second to move the time setting forward by 15 minutes.

Crown: Rotate to move the time setting forward or back one hour.

- Changing the hour and minute hand settings causes the 3D Globe Dial to revolve accordingly. Setting the hour and minute hands to the current time at your location should cause your Home City time zone to move to the dial's ▽ mark.
- If your Home City time zone does not move to the dial's ▽ mark when you set the hour and minute hands to the current time at your location, change the hour and minute hand setting so your Home City time zone moves to the dial's ▽ mark, and then configure the appropriate date and time settings.

[Setting the Time and Date](#)

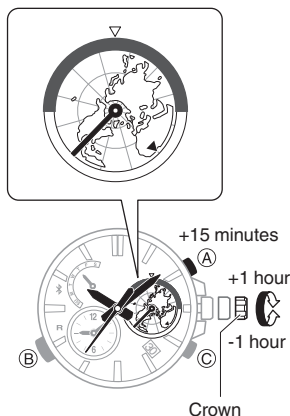

3. Push the crown back in.
The 3D Globe Dial will revolve and move to the position of the current time setting.

Note

- You can use the 3D Globe Dial to view standard times. You cannot use it to view summer times.

Setting the Time and Date

While the watch is connected to a phone, it will automatically adjust its day and time settings to those of the phone. If the watch is not connected to a phone, use the procedure below to adjust its day and time settings.

1. Pull out the crown to the second click.
2. Hold down the (B) button for about one second.
This causes the second hand to move to 12 o'clock, and enables the minute setting operation.

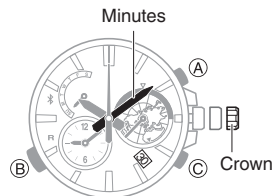

3. Rotate the crown to change the minute setting.
• The Dual Time setting is also adjusted in accordance with the current time setting.
4. Press (B).
This enables the hour setting operation.

5. Rotate the crown to change the hour setting.
• You can determine whether the time setting is a.m. or p.m. by checking the Home City position on the 3D Globe Dial.

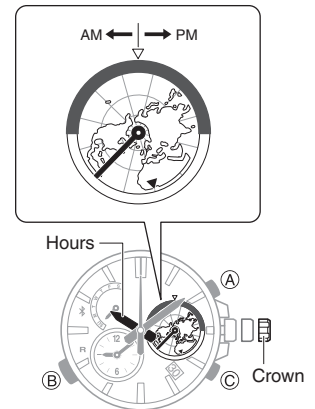

6. Press (B).
This enables the year 10's digit setting operation.
7. Rotate the crown to change the year 10's digit.

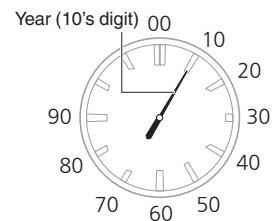

8. Press (B).
This enables the year one's digit setting operation.
9. Rotate the crown to change the year one's digit.

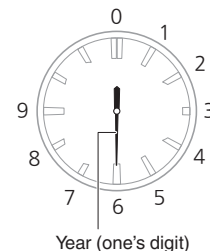

10. Press (B).

This enables the month setting operation.

11. Rotate the crown to change the month setting.

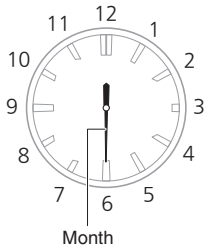

12. Press (B).

This enables the day setting operation.

13. Rotate the crown to change the day.

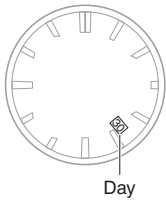

14. On a time signal at the top of a minute, push the crown back in.

Configuring Dual Time Settings

Dual Time lets you keep track of the current time in another time zone in addition to your Home City zone.

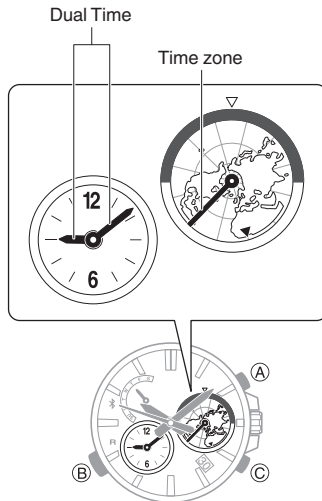

1. Pull out the crown to the first click.
2. Set the small hour and minute hands to the time you want.

(A) button: Hold down for about one second to advance the time setting by 15 minutes.

Crown: Rotate to move the time setting forward or back one hour.

- Also move the time zone hand to the time zone whose time you want to set.
- You can check whether the Dual Time is showing a.m. or p.m. by checking the time Zone hand.

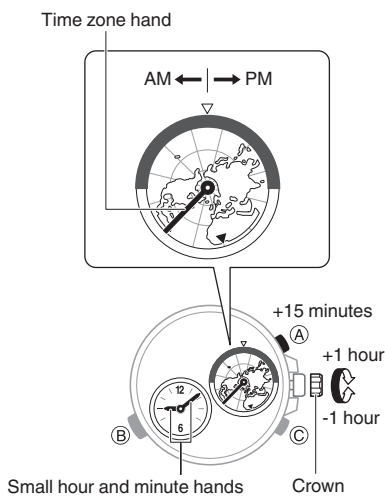

3. Push the crown back in.

Note

- When summer time is being applied in your time zone, the time zone hand will indicate a location to the right of your actual time zone.

Swapping the Home City Time and Dual Time

You can swap your Home City with the Dual Time by holding down (A) for about three seconds.

For example, when your Home City is Tokyo and your Dual Time city is New York, swapping results in the settings shown below.

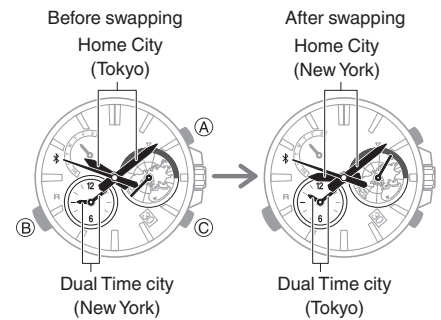

Note

- If the current times were set manually on the watch (not automatically by the phone), the dates will not be swapped. Only the times are swapped.

Hand Alignment Correction

Strong magnetism or impact can cause the time indicated by the hands and the day indicator to go out of alignment. If this happens, correct hand alignment.

To correct hand alignment

1. Pull out the crown to the first click.
2. Hold down (C) for about five seconds.
This enables adjustment of second and minute hand alignment.

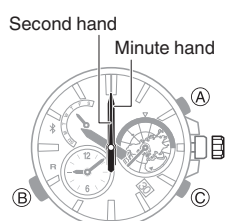

3. Rotate the crown to align the second and minute hands with 12 o'clock.
4. Press (B).
This enables adjustment of hour hand alignment.

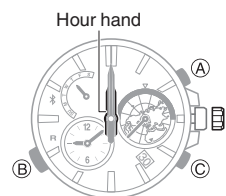

5. Rotate the crown to align the hour hand with 12 o'clock.
6. Press (B).
This enable adjustment of the small hour and minute hands, and the time zone hand.

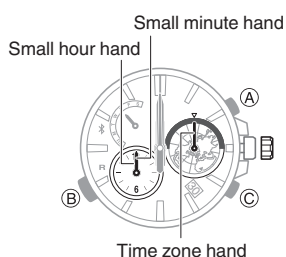

7. Rotate the crown to align the small hour and minute hands with 12 o'clock, and the time zone hand with ▽.

8. Press (B).
This enables adjustment of 3D Globe Dial alignment.

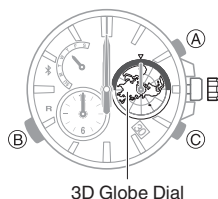

9. Rotate the crown to align ▲ (UTC zone) with the ▽.
10. Press (B).
This enables adjustment of day of the week setting.

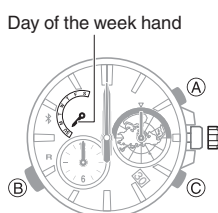

11. Rotate the crown to align the day of the week hand in the center of "SU".
12. Press (B).
This enables adjustment of day indicator alignment.

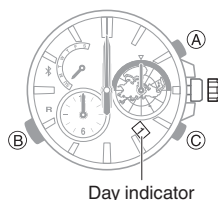

13. Rotate the crown to align "1" in the center of the day indicator.
 - The day of the week hand will move in accordance with the day indicator setting. Make sure that the day of the week hand is in the center of "SU".
14. Push the crown back in.

Moving To Another Time Zone

Use the procedure below to easily change day and time settings of the watch to a destination location.

● Before Boarding

1. Configure the World Time (Dual Time) to the current time at your destination.

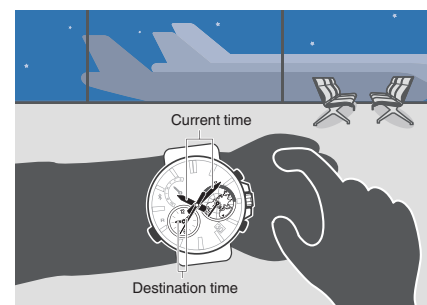

- 🔗 [Configuring World Time Settings](#)
- 🔗 [Configuring Dual Time Settings](#)

2. Disable auto time adjustment.
 - 🔗 [Using the Watch in a Medical Facility or Aircraft](#)

● After Arriving

1. Swap the origin time zone time with the destination time zone time.

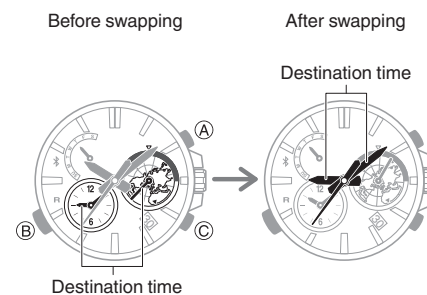

- 🔗 [Swapping the Home City Time and Dual Time](#)

2. Enable auto time adjustment.
 - 🔗 [Using the Watch in a Medical Facility or Aircraft](#)

Other Information

This section provides non-operational information you also need to know. Refer to this information as required.

Summer Time Switching

● Connecting with a Phone to Switch

After the watch is connected with a phone, summer time switching of Home City time and World Time is performed in accordance with the CASIO WATCH+ setting (Auto/ON/OFF) as described below.

Auto:

After the watch is connected with a phone, summer time is displayed for the current location time or World Time when it is within the summer time period. Otherwise standard time is displayed.

ON:

The watch always displays summer time.

OFF:

The watch always displays standard time.

● Auto Summer Time Switching

When the watch is connected to a phone, it is sent summer time period information for your Home City. If there is a World Time City specified with CASIO WATCH+, information for that city will also be sent. If the CASIO WATCH+ summer time setting is "Auto", the watch will automatically keep track of the summer time period and perform summer time switching automatically, even if it is not connected with the phone.

Supported Phone Models

For information about supported phone models, visit the CASIO Website.

http://world.casio.com/os_mobile/wat/

Specifications

Accuracy at normal temperature:

±15 seconds a month

Timekeeping:

Hour, minute, second, day (2000 to 2099 full auto calendar), day of the week

Dual Time:

Hour, minute, swapping with Home City time

Mobile Link:

Auto Time Adjustment

Auto time adjustment at regularly scheduled times.

Phone Finder

Watch operation sounds the alert of the mobile phone.

Auto Summer Time Switching

Automatic switching between standard time and summer time.

Hand position correction

Data Communication Specifications

Bluetooth® SMART

Communication range: 2 meters max. (depends on environment)

Other:

Power Saving, Low Battery alert, Current time indication around the world (3D Globe Dial)

Power Supply:

Solar panel and one rechargeable battery

Approximate Battery Life:

5 months

Conditions

Auto Time Adjustment: 4 times/day

Mobile Link Precautions

● Legal Precautions

- This watch complies with or has received approval under the radio laws of various countries and geographical areas. Using this watch in an area where it does not comply with or has not received approval under applicable radio laws may be a criminal offense. For details, visit the CASIO Website.

<http://world.casio.com/ce/BLE/>

- Use of this watch inside of aircraft is restricted under the aviation laws of each country. Be sure to follow the instructions of airline personnel.

● Safety Precautions

⚠ WARNING Wireless

- Inside of a medical facility or on an aircraft, be sure to follow the instructions of persons in charge concerning the use of radio wave emitting devices. Electromagnetism emitted by the watch may affect instrumentation, which creates the risk of accident.
- Do not use this watch in the vicinity of high-precision electronic equipment or electronic equipment that handles weak signals. Doing so can cause operational or other problems with the electronic equipment, which creates the risk of accident.
- People who are fitted with a pacemaker should keep this watch away from their chest area. Magnetism can affect the operation of pacemakers and other medical devices. Should you ever start to feel any abnormality, immediately move the watch away from you and consult a physician

● Precautions when using Mobile Link

- When using this watch in combination with a phone, keep the watch and phone close to each other. A range of two meters is recommended as a guideline, but the local environment (walls, furniture, etc.), the structure of a building, and other factors may require a much closer range.
- This watch can be affected by other devices (electrical devices, audio-visual equipment, office equipment, etc.) In particular, it can be affected by operation of a microwave oven. The watch may not be able to communicate normally with a phone if a microwave oven is operating nearby. Conversely, this watch may cause noise in radio reception and the video image of a TV.
- Bluetooth of this watch uses the same frequency band (2.4 GHz) as wireless LAN devices, and use of such devices in close proximity of this watch may result in radio interference, slower communication speeds and noise for the watch and the wireless LAN device, or even communication failure.

● Stopping Radio Wave Emission by This Watch

The watch is emitting radio waves whenever the second hand is pointing to ⌘ (Bluetooth connected) or “R” (Bluetooth connection standby). Even if the second hand is not pointing at ⌘ or “R”, the watch will attempt to connect with a phone four times a day to adjust its time settings.

When in a hospital, on an aircraft, or in any other area where the use of radio waves is not allowed, use CASIO WATCH+ to disable syncing between the watch and phone.

For details, see “Using the Watch in a Medical Facility or Aircraft”.

Copyrights and Registered Copyrights

- Bluetooth® is a registered trademark of Bluetooth SIG, Inc.
- iPhone and App Store are registered trademarks of Apple Inc. in the United States and other countries.
- iOS is a trademark or registered trademark of Cisco Systems, Inc.
- GALAXY, GALAXY Note, and GALAXY S are registered trademarks of Samsung Electronics Co., Ltd.
- Android and Google Play™ are registered trademarks of Google Inc.
- Other company names and product names used herein are trademarks or registered trademarks of their respective companies.

Troubleshooting

I can't pair the watch with a phone.

Q1 I've never been able to establish a (pairing) connection between the watch and phone.

Are you using a supported phone model?

Check if the phone model and its operating system are supported by the watch.
For information about supported phone models, visit the CASIO Website.

↓ http://world.casio.com/os_mobile/wat/

Is CASIO WATCH+ installed on your phone?

The CASIO WATCH+ needs to be installed in order to connect with the watch.

↓ [🔗 ① Installing required app on your phone](#)

Are your phone's Bluetooth settings configured correctly?

Configure the phone's Bluetooth settings. For details about setting procedures, see your phone documentation.

iPhone Users

- “Settings” → “Bluetooth” → On
- “Settings” → “Privacy” → “Bluetooth Sharing” → “CASIO WATCH+” → On

Android Users

- Enable Bluetooth.

Other than the above.

Some phones need to have BT Smart disabled to use CASIO WATCH+. For details about setting procedures, see your phone documentation.

On the Home Screen, tap: “Menu” → “Settings” → “Bluetooth” → “Menu” → “BT Smart settings” → “Disable”.

Q2 I can't establish a connection (pairing) between the watch and a newly purchased phone.

To connect with a newly purchased smartphone, you will need to perform the pairing operation again with the new smartphone. Use CASIO WATCH+ to delete the pairing information from your current (old) smartphone, and then pair the watch with the new smartphone.

🔗 [If you purchase another phone](#)

I can't reconnect the watch and phone.

Q1 The watch will not re-connect with the phone after they are disconnected.

Is CASIO WATCH+ running on your phone?

Check if CASIO WATCH+ is running on the phone. On the phone's Home Screen, tap the CASIO WATCH+ icon. Then on the watch, hold down the CONNECT button (B) for about 1.5 seconds.

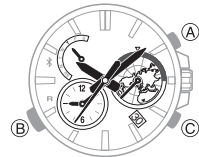

Have you tried turning your phone off and then back on again?

Turn the phone off and then back on, and then tap the CASIO WATCH+ icon. Next, on the watch, hold down the CONNECT button (B) for about 1.5 seconds.



Q2 The phone is in the Airplane Mode.

Connection with the watch is not possible while the phone is in the Airplane Mode. After exiting the phone's Airplane Mode, go to its Home Screen and tap the "CASIO WATCH+" icon. Then on the watch, hold down the CONNECT button (B) for about 1.5 seconds.

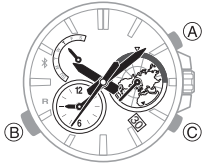

Q3 I changed the phone's Bluetooth from enabled to disabled, and now I can't connect anymore.

On the phone, disable and then re-enable Bluetooth, and then go to the Home Screen and tap the "CASIO WATCH+" icon. Next, on the watch, hold down the CONNECT button (B) for about 1.5 seconds.



Q4 I can't connect after turning off the phone.

Turn on the phone and tap the CASIO WATCH+ icon. Then on the watch, hold down the CONNECT button (B) for about 1.5 seconds.



Phone-Watch Connection

Q1 I can't establish a connection between the phone and watch.

Have you tried turning your phone off and then back on again?

Turn the phone off and then back on, and then tap the CASIO WATCH+ icon. Next, on the watch, hold down the CONNECT button (B) for about 1.5 seconds.

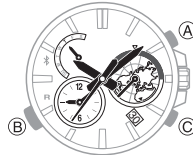

Has the watch been re-paired with the phone?

After unpairing the watch and phone, re-pair them again.

[Unpairing](#)

If you are unable to establish a connection...

Delete the pairing information from the watch, and then re-pair the watch and phone.

[See the Note under "Unpairing".](#)

Changing to a Different Phone Model

Q1 Connecting the current watch to another phone.

Clear pairing information from the watch you are currently using, and then pair with another phone.

[If you purchase another phone](#)

Phone Finder

Q1 Phone Finder does not work.

Are the phone and watch disconnected?

Phone Finder does not work during Bluetooth connection.

Is CASIO WATCH+ running on your phone?

Phone Finder will not work unless CASIO WATCH+ is running. On the Home Screen, tap the CASIO WATCH+ icon.

Other than the above.

If the phone does not respond after a few seconds, it could mean that the phone is located too far from the watch. Change to a different location and try again.

Q2 It takes some time before the phone responds.

The phone will emit a tone when a connection is established with the watch, which takes a few seconds.

Q3 The phone cannot be found even when it is close to the watch.

Since communication is performed using radio waves, the watch may not be able to find the phone even if it is within two meters. Certain environments may make the allowable communication range very short.

Auto Time Adjustment

Q1 When does the watch sync its time setting with the phone?

The watch will connect with the phone and perform auto time adjustment at around 5:00 a.m., 11:00 a.m., 5:00 p.m. and 11:00 p.m. The connection is automatically terminated after auto time adjustment is complete.

Q2 The watch time setting is not adjusted when an auto adjustment time is reached.

Is auto time adjustment late relative to a scheduled time?

Note that auto time adjustment is not performed for 24 hours after swapping of the Home Time and World Time, or after the time setting is adjusted manually on the watch. Auto time adjustment will resume 24 hours after either of the above operations is performed.

Is auto time adjustment enabled?

Auto time adjustment will not be performed at the scheduled times unless it is enabled. Establish a connection between the watch and phone, and then use CASIO WATCH+ to enable auto time adjustment.

[Using the Watch in a Medical Facility or Aircraft](#)

Q3 Time is not displayed correctly.

The phone's time setting may not be correct.

① Correct the phone's time setting.

iPhone Users

- "Settings" → "Privacy" → Turn on "Location Services" → "System Services" → Turn on "Setting Time Zone".

Android Users

- Refer to your phone's user documentation.

② Establish a connection between the watch and phone, and correct the time setting.

[Auto Time Adjustment](#)

World Time

Q1 The time for a World Time City is not correct.

The summer time start date and time, end date and time, or other rules were changed by authorities.

Q2 Why does the time zone hand indicated a zone that is different from my World Time City?

The Time zone hand will indicate the time zone to the right (+1 hour) of your World Time City's time zone if summer time is being observed.

Hand Movement and Indications

Q1 Why can't I perform any button operations while high-speed hand movement is in progress?

Button operations are disabled while high-speed hand movement is in progress after a watch setting is changed, etc. Wait until the hands stop moving before performing button operations.

Q2 The second hand is jumping at two-second intervals.

Battery power is low. Keep the watch exposed to light until it recharges sufficiently.

[Charging the Watch](#)

Q3 All hands are stopped at 12 o'clock and buttons do not work.

The battery is dead. Keep the watch exposed to light until the battery recharges sufficiently.

[Charging the Watch](#)

Q4 The hands suddenly start moving at high speed.

This is due to one of the reasons below, and does not indicate malfunction. Simply wait until normal hand movement resumes.

- The watch is recovering from a power saving state.
 - [Power Saving](#)
- Establish a connection with the phone and correct the time setting.
 - [Auto Time Adjustment](#)

Q5 Hands are stopped and buttons do not work.

The watch is in the charge recovery mode. Wait until the recovery process is complete (for about 15 minutes). The watch will recover more quickly if you place it in a brightly lit location.

Q6 Hands and the day indicator are out of alignment.

Strong magnetism or impact may cause the hands of the watch to go out of alignment. Use CASIO WATCH+ to correct hand alignment.

[Correcting Hand Alignment](#)

Q7 The time setting is correct, but the day indicator is between days.

The day is in the process of changing. For information about how the day changes, see the section below.

[Hands and the Day Indicator](#)

Crown Operations

Q1 Nothing happens when I rotate the crown.

Leaving the crown pulled out for more than nine minutes without performing any operation will automatically disable crown operation. Push the crown back in to its normal position and then pull it out again.

[Using the Crown](#)

Q2 Crown operation does not work.

Crown operation is disabled while high-speed hand movement is in progress after a watch setting is changed, etc. Wait until the hands stop moving before performing crown operations.

Charging

Q1 The watch does not work even though it is exposed to light.

The watch stops operating whenever the battery goes dead. Keep the watch exposed to light until it recharges sufficiently.

[Solar Charging](#)